

Model: Ember

Outdoor Flame Heater

Owner's Manual

Read these instructions before lighting this appliance.

DANGER

If you smell gas:

1. Shut off gas to the appliance.
2. Extinguish any open flame.
3. If odor continues, keep away from the appliance and immediately call your gas supplier or fire department.

WARNING

Do not store or use gasoline or other flammable vapors and liquids in the vicinity of this or any other appliance.

An LP-cylinder not connected for use shall not be stored in the vicinity of this or any other appliance.

WARNING

For Outdoor Use Only.

Installer: Leave this manual to the owner for future use.

Consumer: Please keep this manual for future reference.

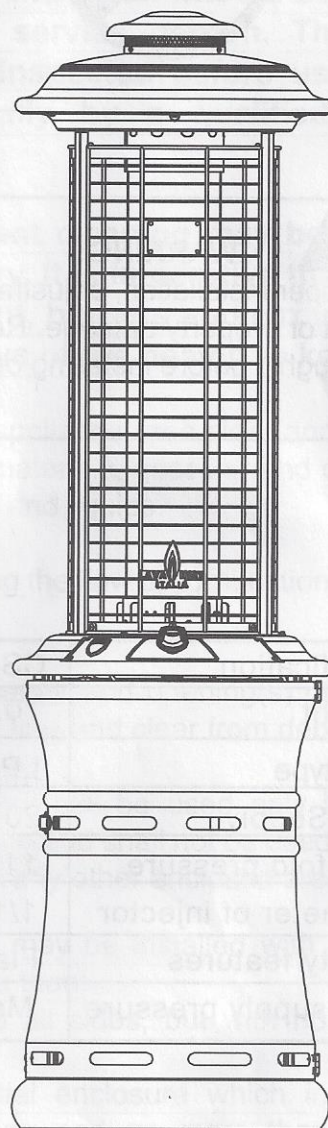

This appliance must be installed in accordance to municipal and local regulations.



Gas-Fired Outdoor Infrared Patio Heaters

Questions, problems, missing / replacement parts? Before returning to your retailer, call our customer service department at 1.888.779.5282, 10 a.m.- 6:00 p.m., PST, Monday-Friday or email cs@lavaheat.com .

WARNINGS AND CAUTIONS

 <h3 style="margin: 0;">DANGER</h3>	<h3 style="text-align: center; margin: 0;">CARBON MONOXIDE HAZARD</h3> <p>This appliance can produce carbon monoxide which has no odor.</p> <p>Using it in an enclosed space can kill you.</p> <p>Never use this appliance in an enclosed space such as a camper, tent or home.</p>
	

 <p>WARNING: Improper installation, adjustment, alteration, service or maintenance can cause injury, death or property damage. Read the installation, operating and maintenance instructions thoroughly before installing or servicing this equipment.</p>

SPECIFICATION

Certification	CSA
Height	70.87" (1.80 m)
Gas type	LPG
Gas Supply	20 lb (9 kg) LP gas cylinder
Manifold pressure	11" W.C.
Diameter of injector	1/13" (1.90 mm)
Safety features	Flame failure device, anti-tilt switch
Gas supply pressure	Max. 250 PSI, Min. 5 PSI

WARNINGS AND CAUTIONS

NOTE: PLEASE READ THE FOLLOWING SAFETY RULES

WARNING:

The installation must conform with local codes or, in the absence of local codes, with the National Fuel Gas Code, ANSI Z223.1/NFPA 54, NFPA58 Natural Gas and Propane Installation Code, CSA B149.1, or Propane Storage and Handling Code, B149.2

The heater, when installed, must be electrically grounded in accordance with local codes or, in the absence of local codes, with the National Electrical Code, ANSI/NFPA 70, or the Canadian Electrical Code, CSA C22.1.

Prior to use, check for damaged parts such as hoses, regulators, pilot or burner.

All leak tests should be done with a soapy solution. NEVER USE AN OPEN FLAME TO CHECK FOR LEAKAGE.

The propane hose with regulator assembly shall be located out of pathways where people may trip over it or in areas where the hose will not be subject to accidental damage.

Children and adults should be alerted to the hazards of high surface temperatures and should stay away to avoid burns or clothing ignition.

Young children should be carefully supervised when they are in the area of the heater.

Clothing or other flammable materials should not be hung from the heater, or placed on or near the heater.

Any guard or other protective device removed for servicing the heater must be replaced prior to operating the heater.

Installation and repair should be done by a qualified service person. The heater should be inspected before use and at least annually by a qualified service person.

More frequent cleaning may be required as necessary. It is imperative that control compartment, burners and circulating air passageways of the heater be kept clean.

Keeping the appliance area clear and free from combustible materials, gasoline and other flammable vapors and liquids.

Not obstructing the flow of combustion and ventilation air.

Keeping the ventilation opening(s) of the cylinder enclosure free and clear from debris.

This appliance shall be used only in a well-ventilated space and shall not be used in a building, garage or any other enclosed area.

An appliance may be installed with shelter no more inclusive than:

With walls on all sides, but with no overhead cover.

Within a partial enclosure which includes an overhead cover and no more than two side walls. These side walls may be parallel, as in a breezeway, or at right angles to each other.

WARNINGS AND CAUTIONS

NOTE: PLEASE READ THE FOLLOWING SAFETY RULES

WARNING:

Within a partial enclosure which includes an overhead cover and three side walls, as long as 30 percent or more of the horizontal periphery of the enclosure is permanently open.

This appliance requires 9kg(20lb) LP-gas supply cylinder.

The LP-gas supply cylinder to be used must be: Constructed and marked in accordance with the Specifications for LP-gas cylinders of the U.S. Department of Transportation (DOT); or the Standard for Cylinders, Spheres and Tubes for Transportation of Dangerous Goods and Commission, CAN/CSA-B339, as applicable;

Provided with a listed overfilling prevention device; and provided with a cylinder connection device compatible with the connection for the appliance.

The cylinder be disconnected when the appliance is not in use.

Storage of an appliance indoors is permissible only if the cylinder is disconnected and removed from the appliance.

A cylinder must be stored outdoors in a well-ventilated area out of the reach of children. A disconnected cylinder must have dust caps tightly installed and must not be stored in a building, garage or any other enclosed area.

The pressure regulator and hose assembly supplied with the appliance must be used, replacement pressure regulators and hose assemblies must be those specified by the appliance manufacturer.

Do not store a spare LP-gas cylinder under or near this appliance;

Never fill the cylinder beyond 80 percent full;

Do not clean the heater with cleaners that are combustible or corrosive.

Place the dust cap on the cylinder valve outlet whenever the cylinder is not in use. Only install the type of dust cap on the cylinder valve that is provided with the cylinder valve. Other types of caps or plugs may result in leakage of propane.

WARNINGS AND CAUTIONS

NOTE: PLEASE READ THE FOLLOWING SAFETY RULES:

Perform a leak test with a soapy solution:

1. To check gas connections.
2. After connecting a new cylinder.
3. Upon re-assembly after disassembly.

This heater is designed to operate with a standard 20 lb propane cylinder with Approved Cylinder Connection.

PREPARATION

Before beginning assembly of product, make sure all parts are present. If any part is missing or damaged, do not attempt to assemble the product. Contact customer service for replacement parts.



PARTS CONTENTS

Please check the contents of the packaging as to whether anything is missing!

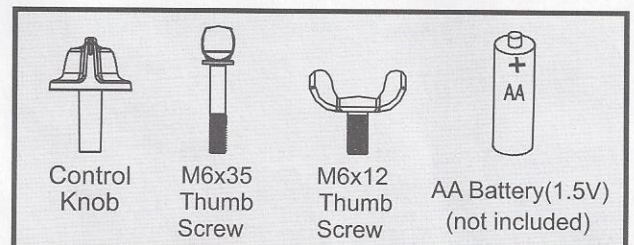
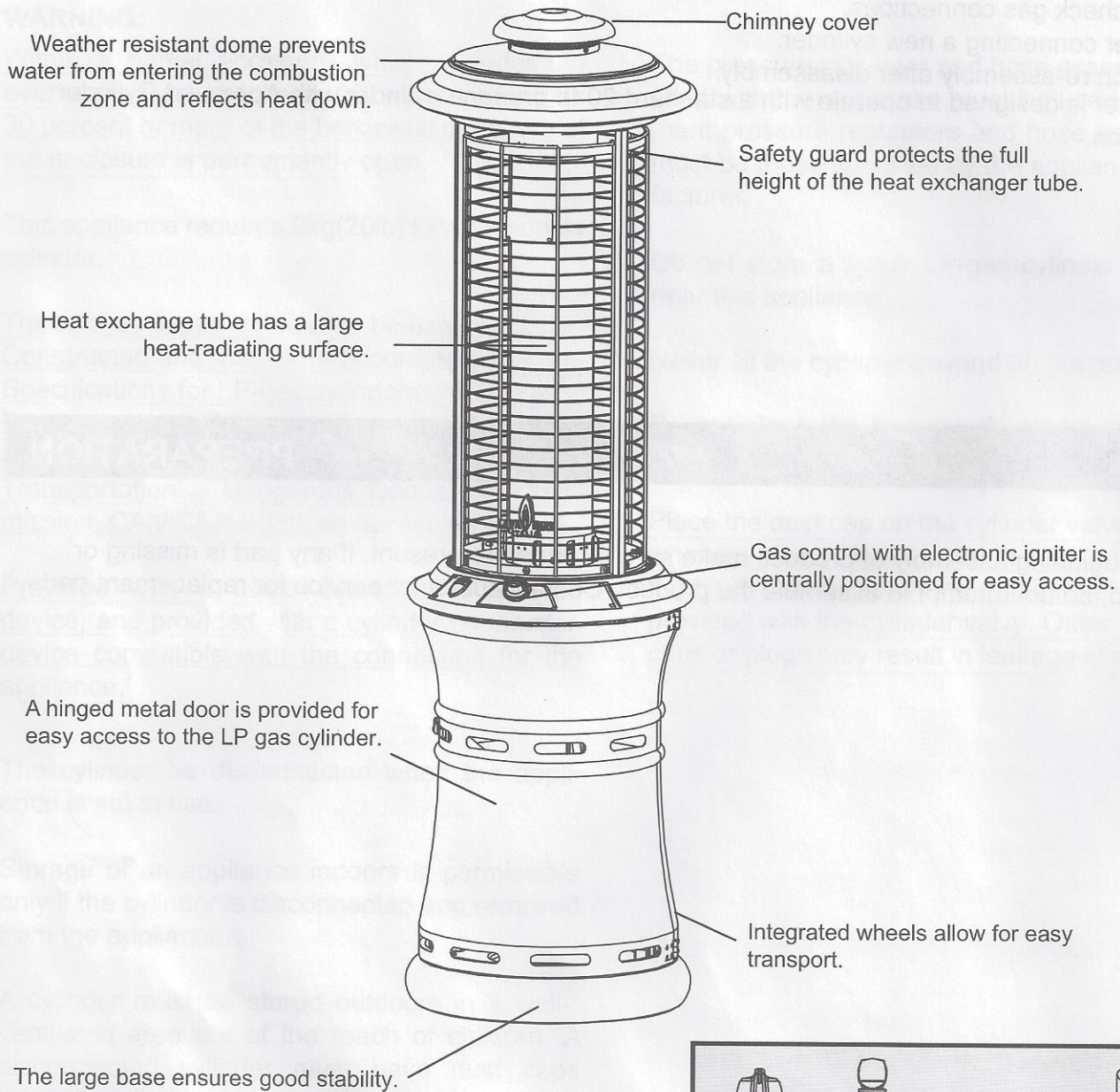

ASSEMBLY INSTRUCTIONS

Warning: This appliance requires installation by a competent person. Proper assembly is the responsibility of the installer.

Step 1: To assemble unit—partially open gas chamber door. Carefully lift dome until entire heat exchange tube is exposed.

Step 1

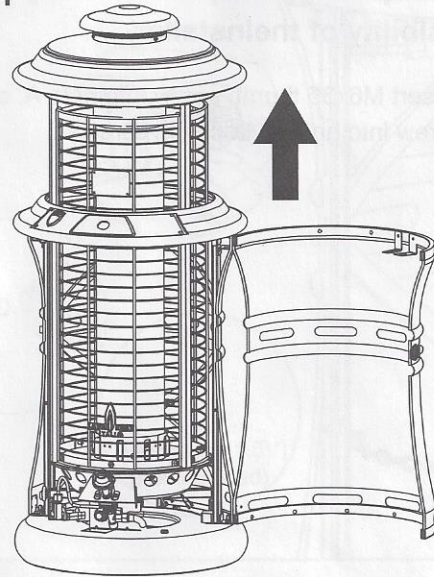

Step 2: After heat exchange tube is fully extended, rotate counter-clockwise until stopped.

Step 2

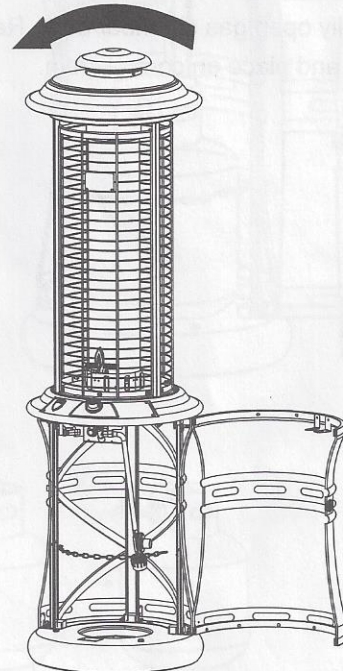

ASSEMBLY INSTRUCTIONS

Warning: This appliance requires installation by a competent person. Proper assembly is the responsibility of the installer.

Step 3: Insert M6x35 thumb screw into hole A, and M6x12 thumb screw into hole B. Lock the screws.

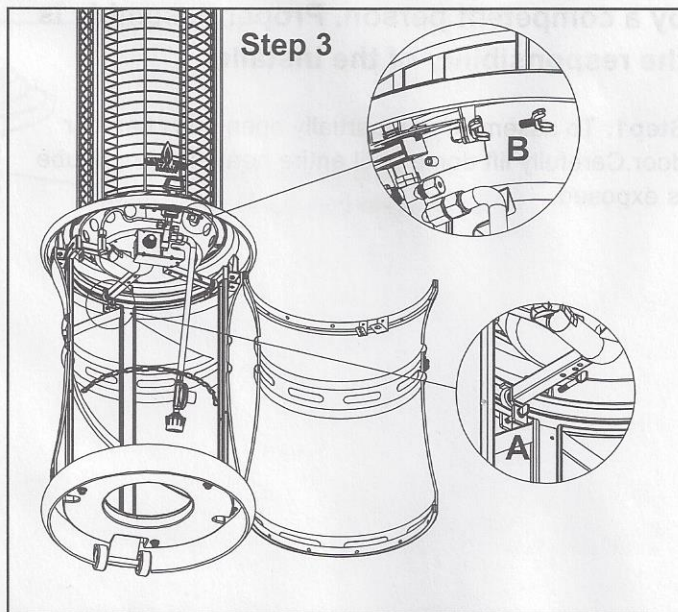

Step 4: Fully open gas chamber door. Remove knob from door and place on control stem.

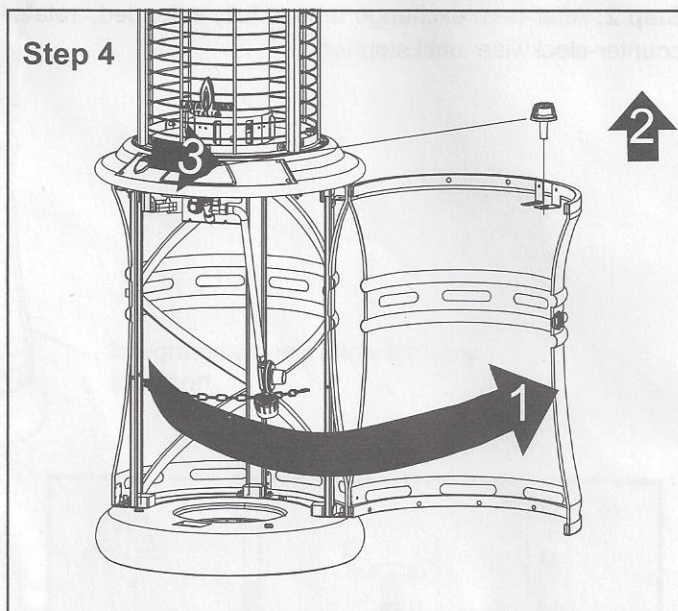

ASSEMBLY INSTRUCTIONS

Warning: This appliance requires installation by a competent person. Proper assembly is the responsibility of the installer.

Step 5: Place battery in compartment below control panel.

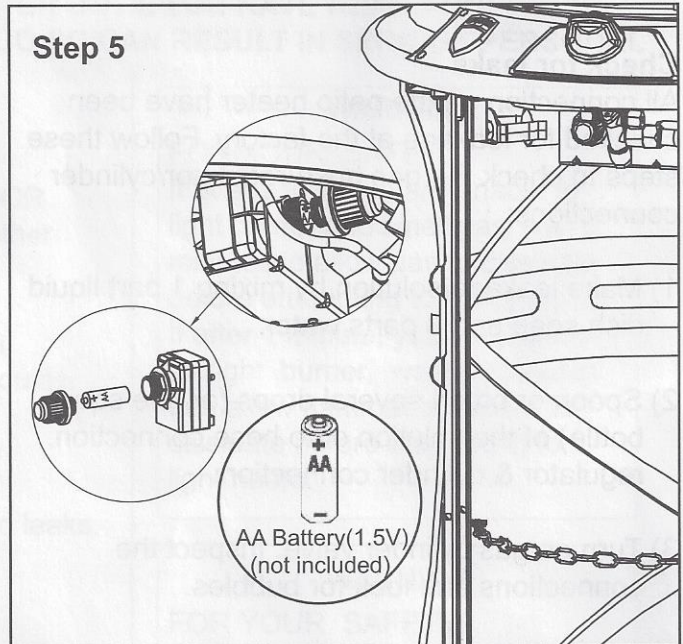

Step 6: Place the gas cylinder (not included) into the base assembly, and fix it with fixing chain. Attach the regulator to the cylinder, turn clockwise to tighten it securely, and then close the door.

Note: Make sure to check for leaks once the cylinder has been replaced. (Refer to the "check for leaks" section on page 10)

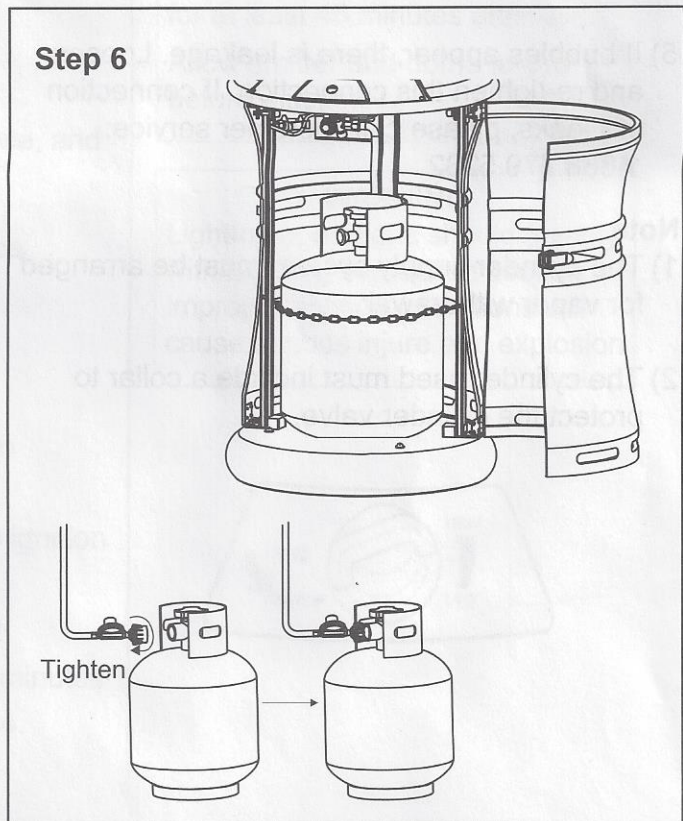

SAFETY CHECK

WARNING : ONLY AN AUTHORIZED GAS TECHNICIAN SHOULD INSTALL THIS PRODUCT.

Check for leaks

All connection on the patio heater have been checked for leakage at the factory. Follow these steps to check the gas hose/regulator/cylinder connections:

- 1) Make leakage solution by mixing 1 part liquid dish soap and 3 parts water.
- 2) Spoon or brush several drops (or use squirt bottle) of the solution onto hose connection, regulator & cylinder connection.
- 3) Turn on gas cylinder valve. Inspect the connections and look for bubbles.
- 4) If no bubbles appear, the connection is safe.
- 5) If bubbles appear, there is leakage. Loosen and re-tighten this connection. If connection still leaks, please call customer service: 1.888.779.5282.

Note:

- 1) The cylinder supply system must be arranged for vapor withdrawal;
- 2) The cylinder used must include a collar to protect the cylinder valve.

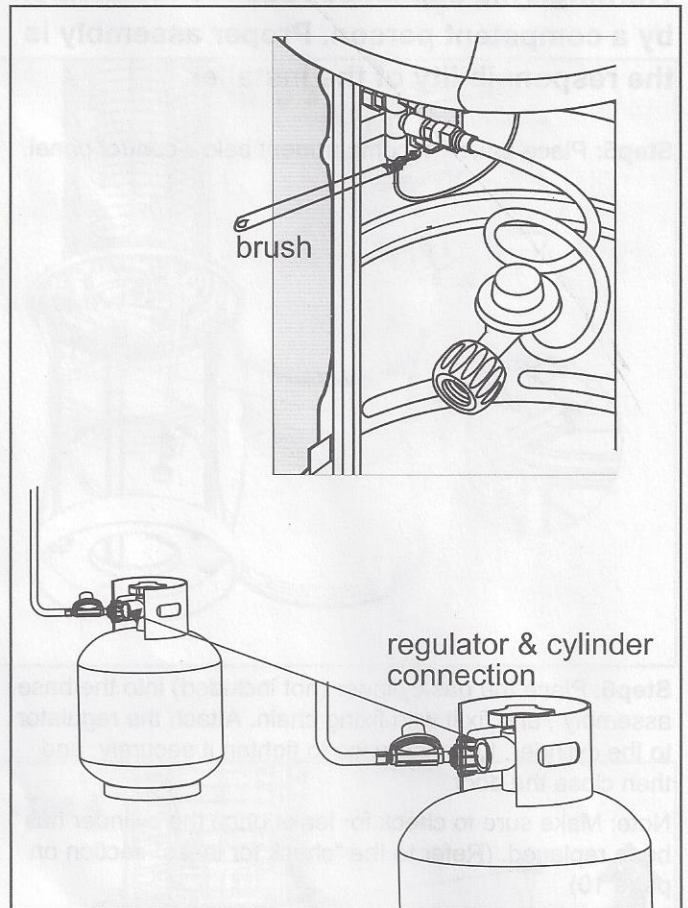

WARNING: DO NOT ATTEMPT TO OPERATE HEATER UNTIL YOU HAVE READ AND UNDERSTAND ALL PRECAUTION . FAILURE TO DO SO CAN RESULT IN SERIOUS PERSONAL INJURY, DEATH, OR PROPERTY DAMAGE.

Before turning gas supply ON

Your heater was designed and approved for **OUTDOOR USE ONLY**. DO NOT use it inside a building or any other enclosed area.

Make sure surrounding areas are free of combustible materials, gasoline, and other flammable vapors or liquids.

Ensure that there is no obstruction to air ventilation.

Be sure all gas connections are tight and there are no leaks.

Be sure the access panel is clear of debris.

Be sure any component removed during assembly or servicing is replaced and fastened prior to starting.

Before Lighting

Heater should be thoroughly inspected before each use, and by a qualified service person at least annually.

If relighting a hot heater, always wait at least 5 minutes.

Lighting instructions

1. Ensure control knob is in OFF position.
2. Depress control knob and turn counter clockwise to IGNITE.
3. Continue to depress knob for 30 seconds, listen to ignition pulse.
4. Then, release knob and turn to adjust heat intensit
5. If pilot does not light, turn knob to OFF and wait 5 minutes for gas vapors to dissipate, then repeat steps 2 to 4.

WARNING

FOR YOUR SAFETY:

If at any time you are unable to light burner and smell gas, wait 5 minutes to allow gas to dissipate before attempting to light heater. If after 1 minute, you are unable to light burner, wait 5 minutes and allow flammable vapors to dissipate before attempting to light heater.

WARNING

FOR YOUR SAFETY:

DO NOT touch or move heater for at least 45 minutes after use.

Allow emitter and dome to cool before touching.

WARNING

Lighting operations should comply with Lighting Instruction section. Improper lighting operations will cause serious injure and explosion.

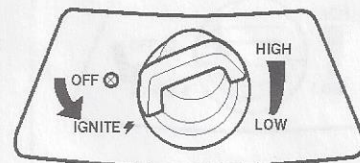

Note: The burner may be noisy when initially turned on.

To eliminate excessive noise from the burner, turn the control knob to the Minimum position.

Then, turn the knob to the level of heat desired.

If you experience any ignition problem consult the following "Troubleshooting".

These lighting instructions must be followed. An unsafe condition can occur if they are not followed correctly.

Flame Characteristic

The flame pattern at the emitter screen should be visually checked whenever heater is operated.

Normally the burner flame is blue, but little yellow flame is acceptable.

If flames extend beyond surface of the emitter grid, or the phenomena of flame lift or light back, or black spot is accumulating on the emitter grid or reflector, the heater should be **turned off** immediately. The heater should not be operated again until the unit is serviced and or repaired.



OPERATION

CAUTION : AVOID INHALING FUMES EMITTED FROM THE HEATER'S FIRST USE. SMOKE AND ODOR FROM THE BURNING OF OILS USED IN MANUFACTURING WILL APPEAR. BOTH SMOKE AND ODOR WILL DISSIPATE AFTER APPROXIMATELY 30 MINUTES. THE HEATER SHOULD NOT PRODUCE THICK BLACK SMOKE.

NOTE:

The burner may be noisy when initially turned on. To eliminate excessive noise from the burner, turn the Control Knob to the "LOW" position. Then, turn the knob to the level of heater desired.

When heater is ON:

Emitter screen will become bright red due to intense heat. The color is more visible at night. Burner will display tongues of blue flame. These flames should not be yellow or produce thick black smoke, indicating an obstruction of airflow through the burners.

Operation pressure checked:

If the flame is very small, this is because the supply pressure is not enough. Please refill gas cylinder.

Re-light:

- 1) Turn the control knob to "OFF" position.
- 2) Wait five (5) minutes before attempting to relight pilot.
- 3) Repeat steps beginning with step 2 of the lighting instruction above.

Shut down instructions:

- 1) Push in and turn control knob clockwise to "OFF" position.
- 2) Turn LP cylinder gas valve clockwise to "OFF" position when heater is not in use.

Note: After use, some discoloration of the emitter screen is normal.

The Event of Gas Leakage:

- 1) Turn the control knob to "OFF" position.
- 2) Turn LP cylinder valve to "OFF" position.
- 3) Wait 5 minutes to allow gas to dissipate.
- 4) If odor continues, immediately call gas supplier.

WARNING : Heater will be hot after use.
Handle with extreme care.

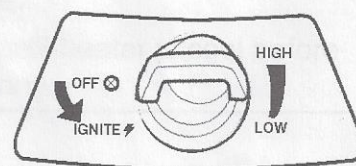
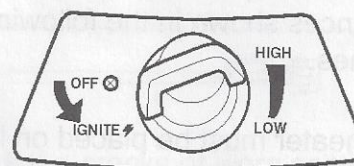

LOCATING HEADER FOR USE

CAUTION: WHEN CERTAIN MATERIALS OR ITEMS ARE LEFT, ABOVE, BESIDE OR UNDER THIS HEATER WHILE IN USE, THEY WILL BE SUBJECT TO RADIANT HEAT AND COULD BE SERIOUSLY DAMAGED.

This heater is primarily used for the heating of outdoor patios, decks, spas, pools and open working areas.

Always make sure that adequate fresh air ventilation is provided. Follow the spacing tolerances shown in the following figure right at all times.

This heater must be placed on level, firm ground.

Never operate in an explosive atmosphere. Keep away from areas where gasoline or other flammable liquids or vapors are stored or used.

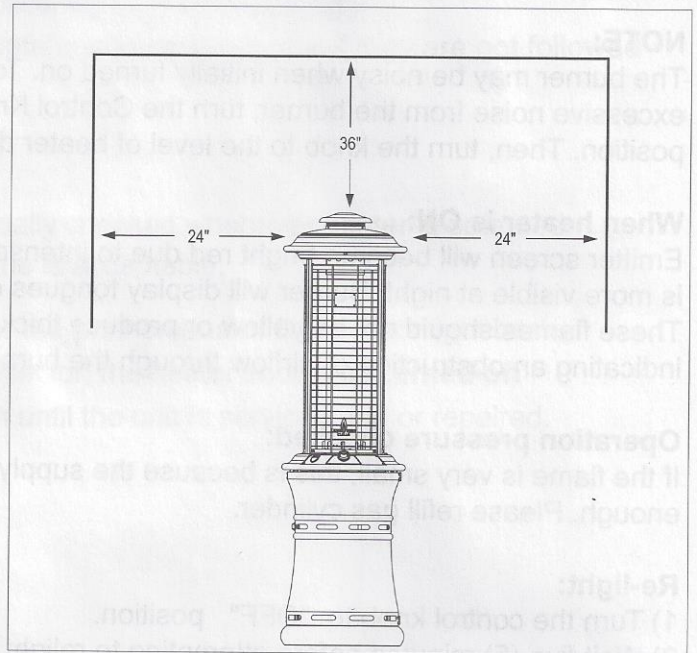

MAINTENANCE/STORAGE

CLEANING AND MAINTENANCE :

To enjoy years of outstanding performance from your heater make sure you perform the following maintenance activities on a regular basis:

- Keep exterior surfaces clean.
- Use warm soapy water for cleaning. Never use flammable or corrosive cleaning agents.
- While washing your unit, be sure to keep the area around the burner and pilot assembly dry at all times. If the gas control is exposed to water in any way, do NOT try to use it. It must be replaced.
- Keep the appliance area free and clean from combustible materials, gasoline and other flammable vapors and liquids; not obstructing the flow of combustion and ventilation air; keeping the ventilation opening(s) of the cylinder enclosure free and clear from debris.
- Visually check burner flames.
- Screw down the screws on pole, take out the burner head assembly.
- Check if there are cracks or worn sections on hose. If yes, please call our customer service to replace hose.
- **At least once a year, the unit should be inspected** for the presence of spiders, spider webs or other insects.
- Air flow must be unobstructed. Keep controls, burner, and circulating air passageways clean. Signs of possible blockage include:
 - Gas odor with extreme yellow tipping of flame.
 - Heater does NOT reach the desired temperature.
 - Heater glow is excessively uneven.
 - Heater makes popping noises.

WARNING:
FOR YOUR SAFETY ;
DO NOT touch or move heater for at least 45 minutes after use. Allow all burner elements to cool before touching.

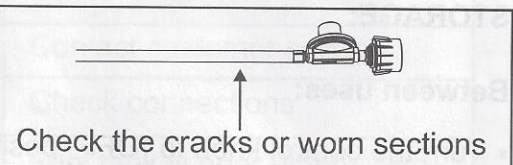

NOTE:
In a salt-air environment (such as near an ocean). corrosion occurs more quickly than normal. Frequently check for corroded areas and repair them promptly.

NOTE:
wait until heater is cool before covering.

MAINTENANCE/STORAGE

- Spiders and insects can nest in burner or orifices. This dangerous condition can damage heater and render it unsafe for use. Clean burner holes by using a heavy-duty pipe cleaner. Compressed air may help clear away smaller particles.
- Carbon deposits may create a fire hazard. Clean dome and engine with warm soapy water if any carbon deposits develop.

STORAGE:

Between uses:

- Turn the control knob to "OFF" position.
- Turn LP cylinder to "OFF" position.
- Store heater upright in an area sheltered from direct contact with inclement weather (such as rain, sleet, hail, snow, dust and debris).
- If desired, cover heater to protect exterior surfaces and to help prevent build up in air passages.

During periods of extended inactivity or when transporting;

- Turn the control knob to "OFF" position.
- Disconnect the regulator from the LP Cylinder by turning counter-clockwise and move to a secure, well-ventilated location outdoors. DO NOT store in a location that will exceed 125 degrees F.
- Store heater upright in an area sheltered from direct contact with inclement weather (such as rain, sleet, hail, snow, dust and debris).
- If desired, cover heater to protect exterior surfaces and to help prevent build up in air passages.

NOTE:

wait until heater is cool before covering.

TROUBLESHOOTING

PROBLEM	PROBABLE CAUSE	SOLUTION
Pilot will not light	Gas valve may be OFF	Turn the gas valve ON
	Tank fuel empty	Refill LP gas tank
	Air in supply system	Purge air from lines
	Loose connection	Check all fittings
Pilot will not stay on	Debris around pilot	Clean dirty area
	Loose connection	Tighten connection
	Thermocouple	Contact customer service
	Gas leak in line	Check connections
	Lack of fuel pressure	Fuel tank is near empty
Burner will not light	Pressure is low	Fuel tank is near empty
	Control valve not ON	Turn valve to ON
	Thermocouple broken	Contact customer service
	Pilot light assembly bent or not in correct location	Contact customer service